



PRIVACY FENCE WITH SCALLOPED PICKET INSTALL INSTRUCTIONS

These instructions are to be used as general guidelines for the installation of your vinyl fence under normal installation conditions. Local conditions may exist which may require changes in the recommended methods of installation noted in these instructions such as extreme weather, bad soil conditions such as expansive soil or poorly compacted soil, extreme winds or heat, etc.

1. Before you begin, familiarize yourself with the installation instructions.

2. Tools Required for Installation:

- a. Measuring tape
- b. Wood or Metal Stakes
- c. Post-hole digger / auger
- d. Post-mix concrete
- e. String
- f. Hammer
- g. Shovel
- h. Spray paint
- i. Wheelbarrow
- j. Level
- k. Duct tape to seal rail ends
- l. Saw
- m. Drill
- n. Wrenches (adjust gate)

3. **KNOW WHAT'S BELOW BEFORE YOU DIG.** Most areas have a call center that you can call to have the utilities located prior to digging. Calling your local utility company is the easiest way to determine who to call. It is important to note that most utility companies will not locate and mark private utility lines that were installed by homeowners or

contractors. Locating utility lines prior to digging may not only save your life, it will also release you of liability in many cases if a line is hit during installation that should have been located but was not. Prior to digging the holes, you should be prepared with emergency numbers to call in the event that a utility line is damaged.

4. **FENCE LAYOUT:**

When you purchased the fence you likely drew a layout and determined the amount of fencing you needed.

HomesteadVinyl.com has a web page that shows how to lay out a fence. It is very helpful to draw the layout of the fence prior to purchasing and installing your vinyl fence.

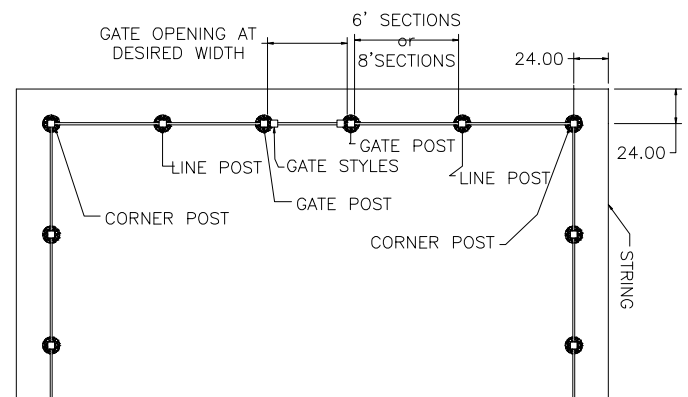

Once you have drawn the fence layout (sample above) and received your product, it is time to mark the locations to dig the holes for the posts.



PRIVACY FENCE WITH SCALLOPED PICKETS INSTALL INSTRUCTIONS (cont.)

To start, hammer a stake at each corner and end location of your fence. Pull a string line between the end and corner posts. This string line represents where the center of your fence will be. Many people offset the string line at this time so that it represents the edge of the fence line; this will save an extra step when you begin setting the posts (see Figure 4.1).

Determine gate post locations and set stakes at these locations. Once you have pulled the string line tight you can now mark the center of each post along the string line.

Mark the post hole location by beginning at one end of the fence and marking the center to center measurement of each post (your center to center measurement can be found on the specification sheet of the style fence purchased). For example, if you have a 96" on center section, you will measure from the center of your first post 96" and mark the ground with upside down marking paint. Continue marking down the string line until you get to the end post. See (Figure 4.1).

Figure 4.1

Mark the center for each post along the string line

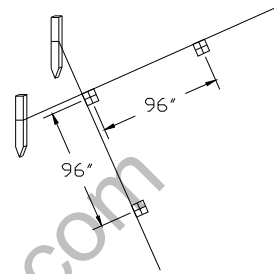

Important: The center to center measurement between any two posts should never exceed the center to center measurement of the fence style you purchase or your panels will not fit.

LAYOUT CUSTOMIZING:

Most projects will not have fence lines that are exactly 6' or 8' increments and will not come out perfectly when measuring. You will have to make one of a few choices.

Option 1 is to have a short section at the end of the line. (Figure 4.2).

FIGURE 4.2

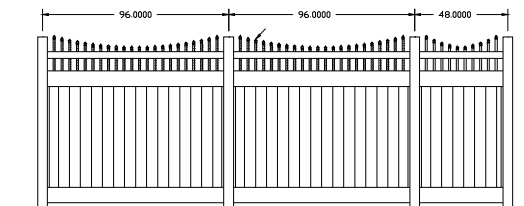

Option 2 is to make each section equal or shorten several of the sections on the



PRIVACY FENCE WITH SCALLOPED PICKETS INSTALL INSTRUCTIONS (cont.)

fence so that you don't have a short section at the end (Figure 4.3).

FIGURE 4.3

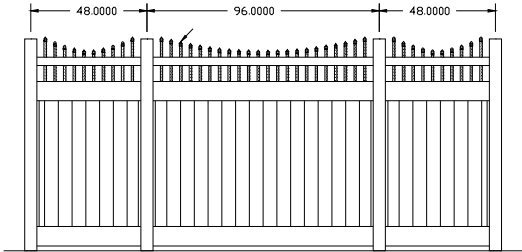

For years I chose option 2 and cut down each section to make every section equal but I found that most people don't notice the section that is short and it saves a lot of time and energy to choose option 1.

5. DIGGING THE HOLES & INSTALLING THE POSTS:

Once you have marked the fence post locations, you are ready to dig the holes.

Note: Different soil conditions and climates require different footing requirements. Seek guidance from local professionals and building codes to determine the proper depth and width of footing. In many areas, a 10" wide hole for a 5" post with a depth of 18-24" is standard and adequate but different regions and local codes vary. In frost regions longer posts are required to keep your fence firm in the ground. Please contact us if you are unsure whether your project requires a different length of post than the standard length and we can help you with your individual needs.

In some regions, a layer of gravel at the bottom of the post holes is added for extra drainage.

Dig holes using a post-hole digger or an auger. See Figure 4.4. Make sure you have called and located all utility lines and that you adjust your fence accordingly to any conflicts.

FIGURE 4.4
POST HOLE DETAIL

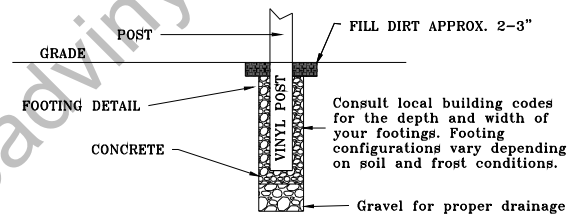

If your project is more than a few holes, you could contact your local small equipment tool rental center to rent a one or two man auger. These generally range from \$60 – 95 a day to rent. If using a one or two man auger, make sure you familiarize yourself with the operator's manual to insure your safety.

Safety Tip: When open holes exist, safety standards should be applied to properly protect the area and notify bystanders of the potential trip and fall hazards that exist with open holes in the ground. Clearly mark the area as a construction zone so others are notified of the dangers that exist.



PRIVACY FENCE WITH SCALLOPED PICKETS INSTALL INSTRUCTIONS (cont.)

Once the holes are dug, the easiest way to set posts in a straight line is by using a string line stretched from one end of the fence to the other. To do this, move the stakes you previously used to mark the hole locations over 2" if installing a 4" post, 2.5" if installing a 5" post. The reason you are moving the stakes over is because they were used to mark the center of the holes and now we need to move them over so the string line is positioned where the outside of the post should be. See Figure 4.1 and 4.5.

Figure 4.5

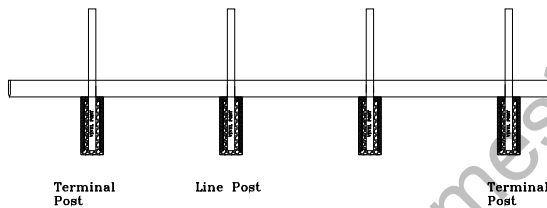

To set the post in a straight line you want to level the post and then place the post just off the string line (you do not want the post touching the string line).

Fill the hole around the post with concrete up to 2" – 3" from top of the hole while keeping the post level and just off of the string.

Plum, square and level the post into position.

You will typically set the post height so the bottom rail has two inches of clearance from the ground. This bottom

gap can be adjusted to fit your project's needs.

Continue setting the next post, making sure that distance between the posts matches the measurement of the specification sheet for the style you purchased. Spacing varies depending on type of fence you purchased. Please See Specification sheet of your style of fence purchased. You can get these spec sheets on homesteadvinyl.com or contact us.

Note: At the end of the runs, sections may need to be shortened to maintain desired layout.

Help Tip: It is important to look often down the line of your fence to make sure that the fence is straight and level and plum. If something looks a little off, go back and adjust as needed. Once you complete a section of fence it is very easy to push a fence post one way or another and tamp at the base of the post to ensure that the top of the fence is straight and level plumb. See Figure 4.6.

Figure 4.6

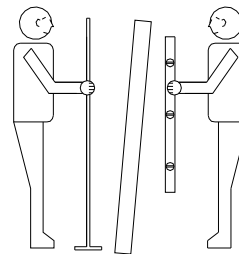



PRIVACY FENCE WITH SCALLOPED PICKETS INSTALL INSTRUCTIONS (cont.)

Getting the Height of the Post Right:

A method commonly used when setting posts is to set the posts close to the right height but primarily focusing on getting the posts straight in a line (post is level and just off the string). Once this has been completed and prior to the concrete setting up, the installer, with the assistance of another will look down the line and pull the post up a little or knock it down by tapping on the top of the post with a block of wood and hammer. The block of wood will help to prevent damage to the vinyl post.

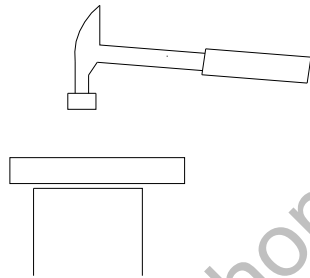

String lines can also be used to help keep the post level but remember that string lines sometimes sag in the middle so it is important to visually look down the top of the fence to make sure the fence is straight. See Figure 4.7.

Figure 4.7



The posts can also be set the right height by placing the bottom rails in the posts and using a level to make sure the posts are set level. When the level is placed on the rails you will know whether to lower raise or lower a particular post.

Grade Note: Contact your fence supplier prior to ordering your fence if your fence grade rises or slopes more than 5%. The fabricator will adjust for this condition by enlarging the routed holes on the posts and rails. The holes on the rails where the pickets go may also need to be enlarged to compensate for the grade changes.

GATE POSTS:

Gate posts should be set at the same time the other fence posts are being installed and using the same methods.

Note: Depending on the size of the gate, it is often advisable to make the post footing larger to support the weight of the gate. A standard 12" x 24" footing is usually adequate for gates up to 6' wide but often installers make this footing larger to be on the safe side and we recommend doing this.

The spacing between the two gate posts is **VERY IMPORTANT** depending on the size of gate you purchased and extra care should be taken to make sure that gate posts are set at the right distance between the gate posts.



PRIVACY FENCE WITH SCALLOPED PICKETS INSTALL INSTRUCTIONS (cont.)

Leveling and plumbing the post is essential to the proper operation of the gate. If gate posts are not level, you will notice it when the gates have been installed. Un-level posts also prevent the gates from operating properly.

The distance between the posts for a gate should be the distance of the gate you purchased. For example, a 4' wide gate purchased from Homestead Fence Company will have a distance between the posts of 48". We have made the gates smaller to compensate for the hinge and latch hardware and so you just need to make sure that you set the gate post to the measurement of the gate size you ordered (4' is 48"; 5' is 60", etc.).

Privacy With Scalloped Pickets Gate

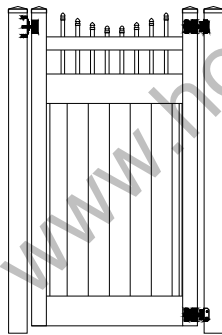

During the post installation process, there is no need to worry about the hardware or any other gate factors, simply focus on setting the gate post to the right spacing height, level and plumb. (See concrete mounting section if you are installing your post on concrete.)

Concrete Mount Details with Tower:

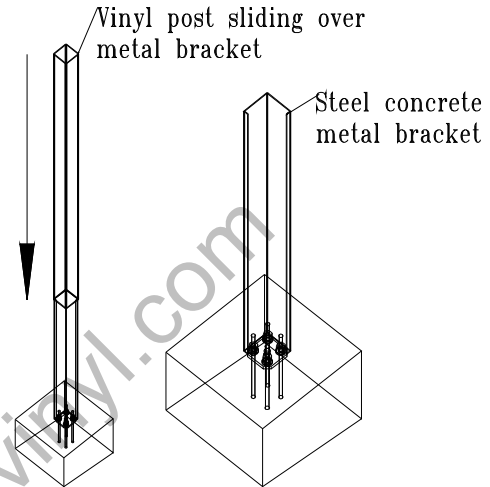

INSTALLING THE BOTTOM RAILS:

Insert the bottom rail into the post, maintaining an equal distance on both sides of the rail. If the section you are installing is smaller than a standard panel, you will need to cut the rail to make it the right length for that section. To do this, measure the distance between the posts and add 3" for the desired rail length. The rail must extend into the post 1 1/2" on both posts. The stiffener in the bottom rail will also need to be cut to the same length as the rail. See Figure 4.8.



PRIVACY FENCE WITH SCALLOPED PICKETS INSTALL INSTRUCTIONS (cont.)

Figure 4.8

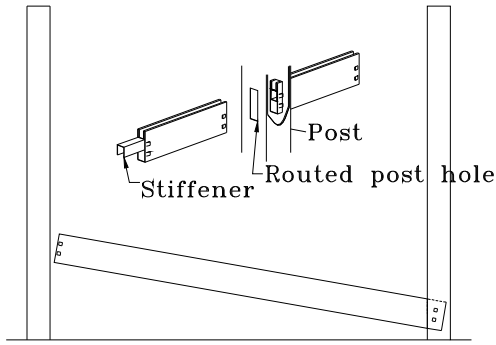
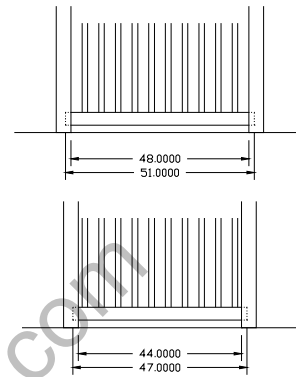

Figure 4.9



The rail can be secured to the post by using notches, rail clips, screws, or glue tabs. Notching is commonly used when a notching tool is available, when one is not available, glue tabs, screws, or rail clips are acceptable methods to secure the rail.

If using glue tabs to secure the rail, once the rail has been properly inserted 1 1/2" into each post you will need to glue a glue tab under the bottom rail on both sides of the rail. The glue tab should be glued against the post to prevent movement of the rail.

Rail clips or notching the rails may also be used in lieu of glue tabs. Each method prevents the rail from coming out of the post at a later time.

Once the rail has been properly inserted 1 1/2" into each post you will need to glue a glue tab under the bottom rail on both sides of the rail, in a manner where it rests against the post to prevent movement of the rail. Rail clips may also be used in lieu of a glue tab, both work great to prevent the rail from popping out of the post at a later time.

Picket Fence Note: In the event that you have a short section and the middle and top rail need to be cut where the rail has been routed for pickets, it is important to make sure that the distance from the first and last picket hole in the rail are equal in distance to each post (this involves cutting both ends of the rail). In other words, sometimes you may have to cut off a portion from each side of the rail to make sure that the distance from the post to the distance of the first picket is equal on both sides of the panel. See Figure 4.9.



PRIVACY FENCE WITH SCALLOPED PICKETS INSTALL INSTRUCTIONS (cont.)

INSTALLING THE U-CHANNEL

Screw the U-channel to the posts on each side of panel. The U-channel covers the cut of the last picket on a privacy fence and provides a clean look to the fence. It also prevents any gaps from becoming visible in the event the post shifts after installation due to any ground movement settling. See Figure 2.1.1.

Figure 4.10

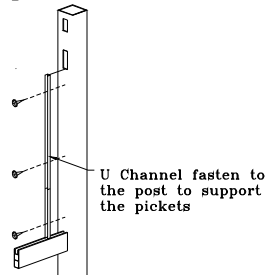

Insert the pickets into the bottom rail.

INSTALLING THE T&G PICKETS

Insert the pickets into the bottom rail of each section by starting at one side and inserting the tongue and groove pickets in the bottom rail. See Figure 4.11.

Figure 4.11

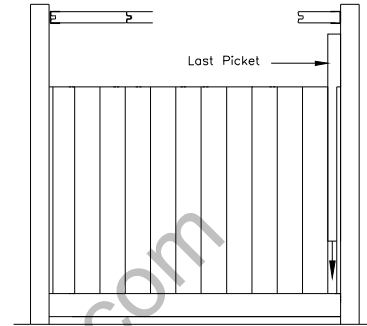

Once all of the pickets have been inserted into a section, measure the distance between the post and the last full picket you can fit on the panel. Measure and cut the last picket to the right width and slide the last picket into place next to the post and into the U-channel attached to the post. This cut is best performed with a table saw however standard field tools such as a sawzall or skill saw can be used effectively. When using a skill saw it is best to use a blade with the maximum amount of teeth per blade such as a plywood blade. When you cut the last picket for the panel, make sure you use the other half to start the next panel. This will insure you have enough pickets to complete your project.

Safety glasses should be worn at all times when cutting and installing vinyl fence to protect your eyes. Manuals for any equipment should be read and understood prior to use of any machinery and equipment. Safety is always first.



PRIVACY FENCE WITH SCALLOPED PICKETS INSTALL INSTRUCTIONS (cont.)

INSTALLING THE MIDDLE RAIL

Insert the middle rail into one side of the post and then into the lower tongue and groove pickets. Push the top rail down until all of the pickets are in place inside of the top rails pocket. Once all pickets are inserted into the middle rail, slide the middle rail into the middle post hole 1 ½" making sure that each side has 1 ½" of rail inserted into both posts. The middle rail can be secured by a set screw, rail clip, or Notch against the post. See Figure 4.12.

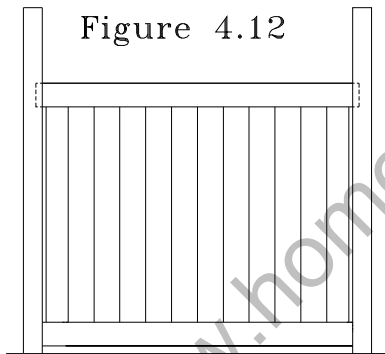

INSTALLING THE TOP RAIL

Insert the top rail into the posts and secure it with a set screw, notchers, or rail clip. See Figure 4.13.

Figure 4.13

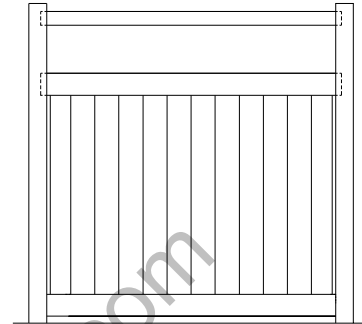

INSTALLING THE TOP PICKETS

Install the pickets by pushing them into the top routed hole in the top rail and sliding the picket all the way down until it inserts into the mid-rail. The pickets are pre-notched and will lock into place once pushed into the middle rail. See Figure 4.14.

Figure 4.14

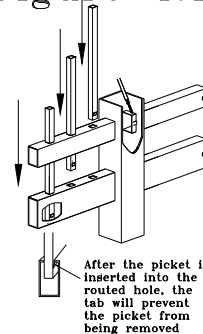

PRIVACY FENCE WITH SCALLOPED PICKETS INSTALL INSTRUCTIONS (cont.)

Figure 4.14

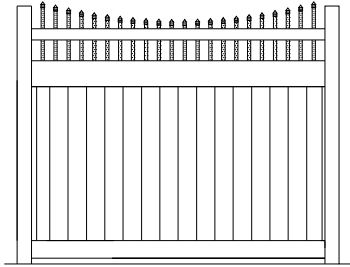
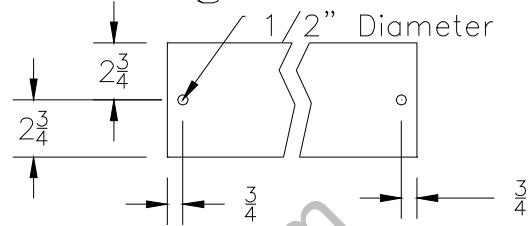

Figure 3.8



Secure the top rail by placing a set screw or rail clip into the rail and next to the inside wall of the post.

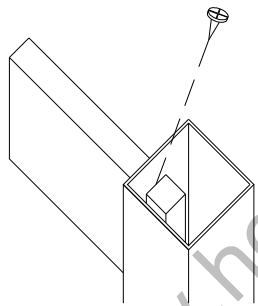
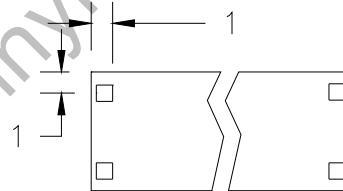

Figure 3.9



If using rail clips, install a rail clip in each end of the rail and secure the rail inside the posts at each end of the rail as shown in Fig 3.11.

INSTALLING THE RAILS

Securing the rails can be accomplished by using rail clips or notches at the end of the rail. If using clips for your ranch rails, drill a 1/2" diameter hole 3/4" from the end of the rail in the center of the rail. (See Figure 3.8) If notching your rails, notches should not be more than 1" from the end of the ranch rail. (See Figure 3.9)

Figure 3.11

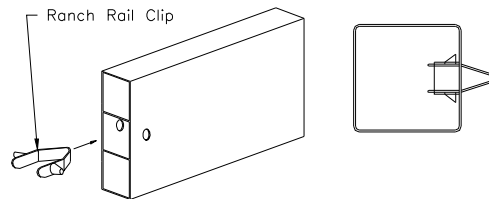

If using notches to secure your rails, notch both ends of the rail and secure the rail inside the post as shown in Figure 3.12.



PRIVACY FENCE WITH SCALLOPED PICKETS INSTALL INSTRUCTIONS (cont.)

Figure 3.12

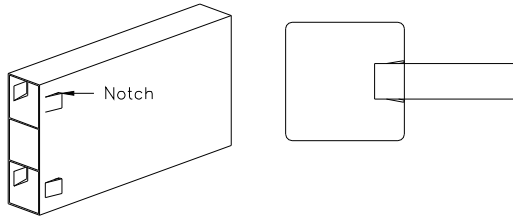

www.homesteadvinyl.com