

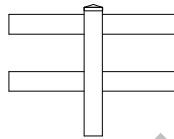

Ranch Rail Vinyl Fence

INSTALLATION INSTRUCTIONS

2 Rail Ranch



3 Rail Ranch

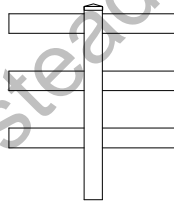

4 Rail Ranch

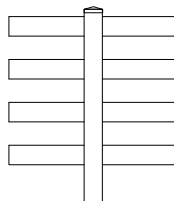

These instructions are to be used as general guidelines for the installation of your vinyl fence under normal installation conditions. Local conditions may exist which may require changes in the recommended methods of installation noted in these instructions



VINYL RANCH RAIL INSTALLATION INSTRUCTIONS (cont.)

such as extreme weather, bad soil conditions such as expansive soil or poorly compacted soil, extreme winds or heat, etc.

1. Before you begin, familiarize yourself with the installation instructions.

2. Tools Required for Installation:

- a. Measuring tape
- b. Wood or Metal Stakes
- c. Post-hole digger / auger
- d. Post-mix concrete
- e. String
- f. Hammer
- g. Shovel
- h. Spray paint
- i. Wheelbarrow
- j. Level
- k. Duct tape to seal rail ends
- l. Saw
- m. Drill
- n. Wrenches (adjust gates)

3. KNOW WHAT'S BELOW BEFORE YOU DIG!

Most areas have a call center that you contact to have the utilities located prior to digging. Calling your local utility company is the easiest way to determine who to call. It is important to note that most utility companies will not locate and mark private utility lines that were installed by homeowners or contractors. Locating utility lines prior to digging may not only save your life, it may also release you of liability in some cases where a utility line is damaged during installation that should have been located but was not. Prior to digging the holes, you should be prepared with emergency numbers to call in the event that a utility line is damaged.

4. FENCE LAYOUT:

When you purchased the fence you likely drew a layout and determined the amount of fencing you needed. Homestead Fence Company has a web page that shows how to lay



VINYL RANCH RAIL INSTALLATION INSTRUCTIONS (cont.)

out a fence. It is very helpful to draw the layout of the fence prior to purchasing and installing your vinyl fence.

Once you have drawn the fence layout (Figure 3.3) and received your vinyl fence materials, it is time to mark the locations to dig the holes for the posts.

To start, hammer a stake at each corner and end location of your fence. Pull a string line between the end and corner posts. This string line represents where the center of your fence will be. Many people offset the string line at this time so that it represents the edge of the fence line; this will save an extra step when you begin setting the posts (see Figure 1.1).

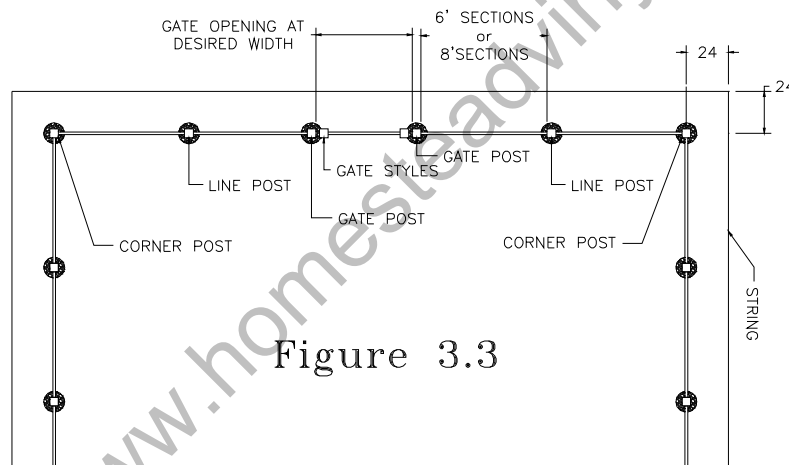

Figure 3.3

Determine gate post locations and set stakes at these locations. Once you have pulled the string line tight you can now mark the center of each post along the string line.

Mark the post hole location by beginning at one end of the fence and marking the center to center measurement of each post. For example, if you have an eight foot on center section, you will measure from the center of your first post 96" and mark the ground with upside down marking paint. Continue marking down the string line every 96" until you get to the end post. See (Figure 3.1).



VINYL RANCH RAIL INSTALLATION INSTRUCTIONS (cont.)

Figure 3.1

Mark the center for each post along the string line

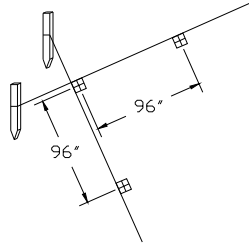

Important: Ranch rail should be set at a maximum 96" center to center measurement, the posts should not be set at a distance greater than this.

LAYOUT CUSTOMIZING:

Most projects will not have fence lines that are not exactly 8' increments and post layouts will not come out perfectly when measuring. You will have to make one of a few choices to adjust for this issue.

Option 1 is to have a short section at the end of the line (Figure 3.2).

Figure 3.2

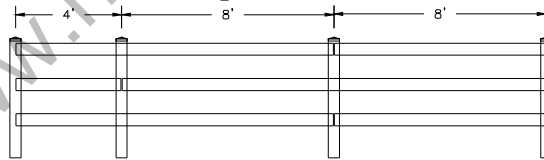

Option 2 is to make each section equal or shorten several of the sections on the fence so that you don't have a short section at the end.

For years I chose option 2 and cut down each section to make every section equal but I found that most people don't notice the section that is short and it saves a lot of time and energy to choose Option 1.



VINYL RANCH RAIL INSTALLATION INSTRUCTIONS (cont.)

5. DIGGING THE HOLES & INSTALLING THE POSTS:

Once you have marked the fence post locations, you are ready to dig the holes.

Note: Different soil conditions and climates require different footing requirements. Seek guidance from local professionals and building codes to determine the proper depth and width of footing. In many areas, a 10” wide hole for a 5” post with a depth of 18-24” is standard and adequate but different regions and local codes vary. In frost regions longer posts are required to keep your fence firm in the ground. Please contact us if you are unsure whether your project requires a different length of post than the standard length and we can help you with your individual needs. In some regions, a layer of gravel at the bottom of the post holes is added for extra drainage.

Dig holes using a post-hole digger or an auger. See Figure 3.4. Make sure you have called and located all utility lines and that you adjust your fence accordingly to any conflicts.

If your project is more than a few holes, you could contact your local small equipment tool rental center to rent a one or two man auger. These generally range from \$60 – 95 a day to rent. For larger projects, bobcats with augers typically work great. If using a one or two man auger, make sure you familiarize yourself with the operator’s manual to insure your safety.

FIGURE 3.4
POST HOLE DETAIL

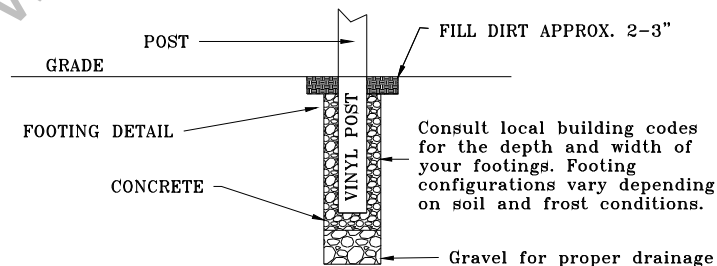

Safety Tip: When open holes exist, safety standards should be applied to properly protect the area and notify bystanders of the potential trip and fall hazards that exist with open



VINYL RANCH RAIL INSTALLATION INSTRUCTIONS (cont.)

holes in the ground. Clearly mark the area as a construction zone so others are notified of the dangers that exist.

Once the holes are dug, the easiest way to set posts in a straight line is by using a string line stretched from one end of the fence to the other. To do this, move the stakes you previously used to mark the hole locations over 2.5". The reason you are moving the stakes over is because they were used to mark the center of the holes and now we need to move them over so the string line is positioned where the outside of the post should be. See Figure 3.1 and 3.5.

Figure 3.5

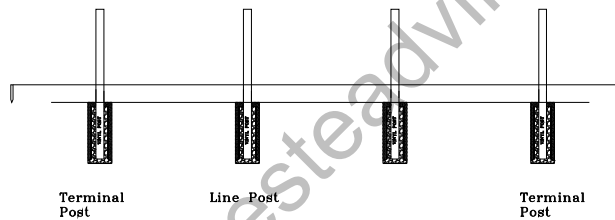

To set the post in a straight line you want to level the post and then place the post just off the string line (you do not want the post touching the string line).

Fill the hole around the post with concrete up to 2" – 3" from top of the hole while keeping the post level and just off of the string.

Plum, square and level the post into position. For suggested post height see Figure 3.2 at end of instructions.

You will typically set the post height so the bottom rail has two inches of clearance from the ground. This bottom gap can be adjusted to fit your project's needs.

Continue setting the next post, making sure that distance between the posts is 96" or less.

Help Tip: It is important to look often down the line of your fence to make sure that the fence is straight and level and plum. If something looks a little off, go back and adjust as needed. Once you complete a section of fence it is very easy to push a fence post one



VINYL RANCH RAIL INSTALLATION INSTRUCTIONS (cont.)

way or another and tamp at the base of the post to ensure that the top of the fence is straight and level plumb. See Figure 3.6

Figure 3.6

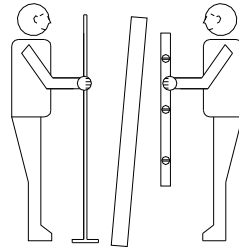

Getting the Height of the Post Right:

A method commonly used when setting posts is to set the posts close to the right height but primarily focusing on getting the posts straight in a line (post is level and just off the string). Once this has been completed and prior to the concrete setting up, the installer, with the assistance of another will look down the line and pull the post up a little or knock it down by tapping on the top of the post with a block of wood and hammer. The block of wood will help to prevent damage to the vinyl post.

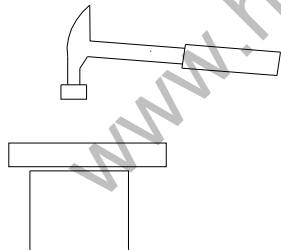

String lines can also be used to help keep the post level but remember that string lines sometimes sag in the middle so it is important to visually look down the top of the fence to make sure the fence is straight. See Figure 3.7.



VINYL RANCH RAIL INSTALLATION INSTRUCTIONS (cont.)

Figure 3.7



The posts can also be set the right height by placing a rail in the posts and using a level to make sure the posts are set level. When the level is placed on the rails you will know whether to lower raise or lower a particular post.

Grade Note: Contact your fence supplier prior to ordering your fence if your fence grade rises or slopes more than 5%. The fabricator will adjust for this condition by enlarging the routed holes on the posts.

GATE POSTS:

Gate posts should be set at the same time the other fence posts are being installed and using the same methods.

Note: Depending on the size of the gate, it is often advisable to make the post footing larger to support the weight of the gate. A standard 12" x 24" footing is usually adequate for gates up to 6' wide but often installers make this footing larger to be on the safe side and we recommend doing this.

The spacing between the two gate posts is **VERY IMPORTANT** depending on the size of gate you purchased. Extra care should be taken to make sure that gate posts are set at the right distance between the gate posts.

Leveling and plumbing the post is essential to the proper operation of the gate. If gate posts are not level, you will notice it when the gates have been installed. Un-level posts also prevent the gates from operating properly.



VINYL RANCH RAIL INSTALLATION INSTRUCTIONS (cont.)

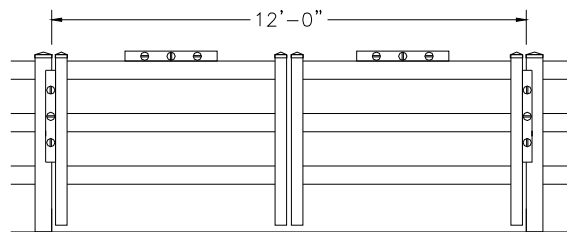

The distance between the posts for a gate should be the distance of the gate you purchased. For example, a 4' wide gate purchased from Homestead Fence Company will have a distance between the posts of 48". We have made the gates smaller to compensate for the hinge and latch hardware and so you just need to make sure that you set the gate post to the measurement of the gate size you ordered (4' is 48"; 5' is 60", etc.). In the example above, the gate ordered was a 12' double gate and the posts are set 12' apart.

During the post installation process, there is no need to worry about the hardware or any other gate factors, simply focus on setting the gate post to the right spacing height, level and plumb. (See concrete mounting section if you are installing your post on concrete.)

6. INSTALLING THE RAILS

Securing the rails can be accomplished by using rail clips or notches at the end of the rail. If using clips for your ranch rails, drill a $\frac{1}{2}$ " diameter hole $\frac{3}{4}$ " from the end of the rail in the center of the rail. (See Figure 3.8) If notching your rails, notches should not be more than 1" from the end of the ranch rail. (See Figure 3.9)

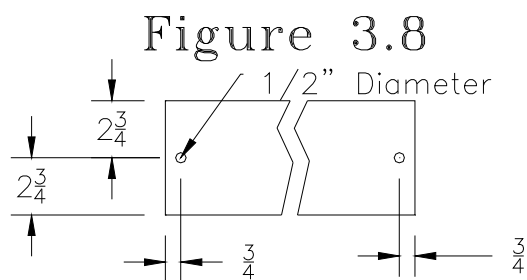



VINYL RANCH RAIL INSTALLATION INSTRUCTIONS (cont.)

Figure 3.9

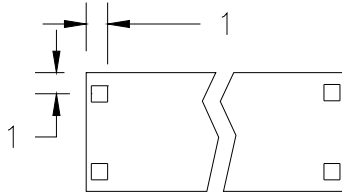

Note: Allow 1/2" between rails inside the post for expansion and contraction of the rails.

Once the posts have been set and the concrete has cured, slide the rail through the bottom, top, and middle rails as shown in Figure 3.10. For 3 and 4 rail staggering the rails so the end is not in the same post for both rails is effective to add additional strength to the fence.

Figure 3.10

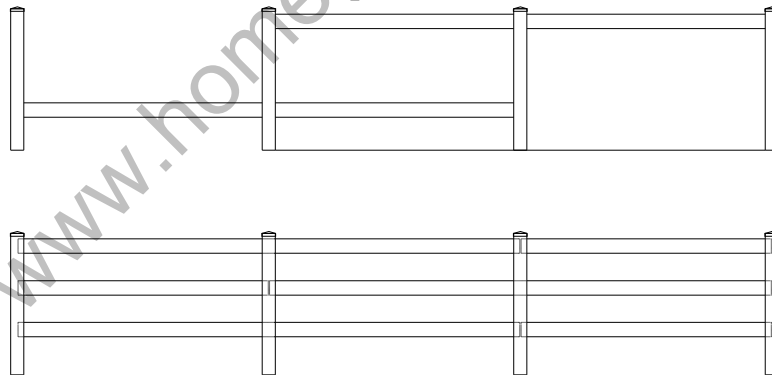

If using rail clips, install a rail clip in each end of the rail and secure the rail inside the posts at each end of the rail as shown in Fig 3.11.



VINYL RANCH RAIL INSTALLATION INSTRUCTIONS (cont.)

Figure 3.11

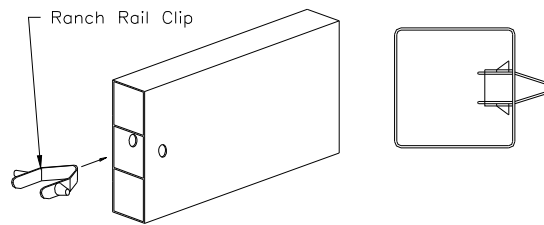

If using notches to secure your rails, notch both ends of the rail and secure the rail inside the post as shown in Figure 3.12.

Figure 3.12

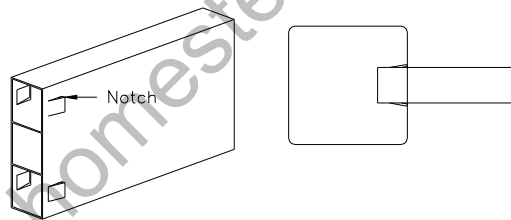

Once the fence has been installed, it is now time to complete the gates.

GATE POSTS AND HARDWARE – GATE INSTALLATION

There are different methods that can be used to make a gate posts stronger such as adding steel inserts and/or concrete to the inside of gate posts.

We prefer the method of adding 2, ½” pieces of rebar to the post and filling the post with concrete. We have used this method on thousands of gates and we feel this method has been tried and proven. See Figure 1.13



VINYL RANCH RAIL INSTALLATION INSTRUCTIONS (cont.)

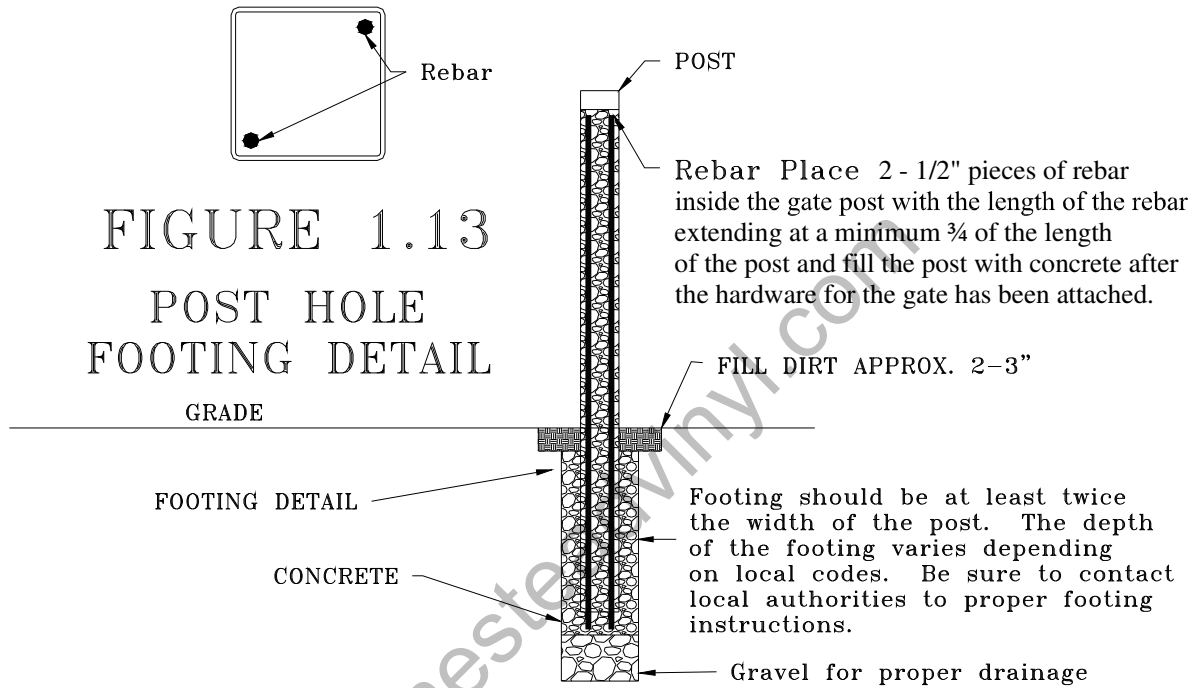

Prior to filling the posts with concrete it is important to screw the gate hardware on the gate posts so you are not screwing into a post filled with concrete. Gate hardware placement does not have to be exact and placement should look something similar to the gate specification diagram below. At this point the gate hardware should be secured only to the post that will hold the gate up and the post that the gate will latch to and not the gate itself.

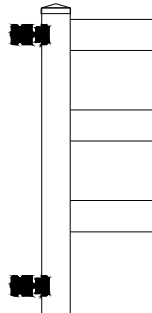

When mixing concrete for gate posts it is important to get a good consistency, too thick and the concrete will not form properly as it is rocky and doesn't fill into the post



VINYL RANCH RAIL INSTALLATION INSTRUCTIONS (cont.)

properly, too soupy and the concrete will run down the rails and not be strong enough as the concrete is diluted with water (many put tape on the end of the rails that insert into gate posts to prevent the concrete from flowing back into the rail).

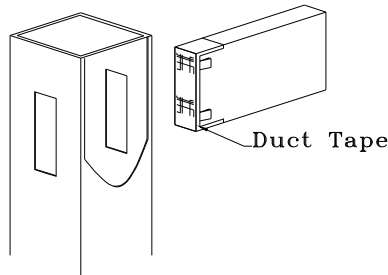

Once you have the right consistency, pour the concrete inside the post and fill the post with concrete. Typically installers use a cup or Gatorade bottle that has been cut at the top to form a funnel. Concrete will likely spill down the side of the post during this stage of the installation. Concrete can be wiped off easily if it is wiped off before the concrete is allowed to cure. Typically we let the concrete dry a little on the outside of the post as we have found it wipes off easier with a dry cloth. If the concrete is on the vinyl for extended period the concrete can be difficult to remove. When concrete is wet and with the help of a little water the concrete will wipe off with a cloth or a sponge.

Let the concrete in the post cure prior to hanging the gate. Cure time varies from geographic location and time of year. During summer months in most locations, this can be the next day. During winter months we have seen this time vary from 1-4 days.

Alternative concrete products may want to be used such as quick curing concrete to speed up this process. Another option is to use a metal stiffener inside of the gate post in lieu of concrete. We have these available and can sell them as requested.

Once the concrete has cured, the gate can be attached to the hardware by adjusting the hinges to the desired gate width and holding or blocking the gate up at the desired height and screwing the hinges to the gate.

Secure the hinges to the gate with the provided screws and adjust the hinges to make sure the gaps on both sides of the gate are equal and the gate is level and swinging properly.

Attach the latch to the gate. The latch pin should fit loose into the latch.



HOMESTEAD
FENCE
C O M P A N Y

VINYL RANCH RAIL INSTALLATION INSTRUCTIONS (cont.)

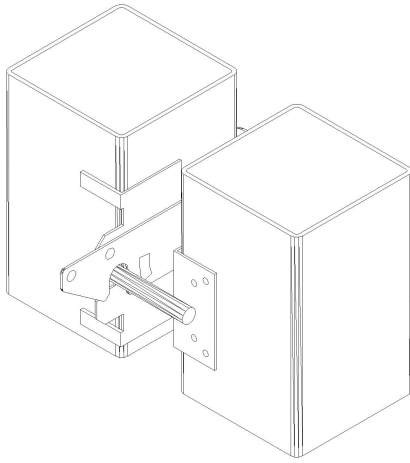

On Double gates it is necessary to install a drop rod assembly on the gate post that has the latch so the gates stay closed.

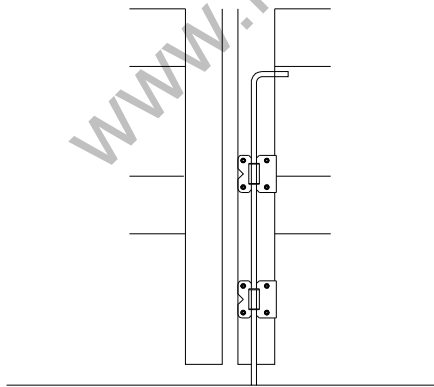



VINYL RANCH RAIL INSTALLATION INSTRUCTIONS (cont.)

ECURE CAPS

Glue caps on the fence and gates onto the top of the post with PVC glue, making sure not to spill or drip glue onto the fence, as certain glues will sometimes yellow. This works best by placing the glue on the cap and not the post and then pressing the gate onto the post.

Enjoy your fence. Follow our maintenance instructions to ensure proper maintenance care for your vinyl fence.

Figure 3.2

